

HCA120S60D1Q

eSiC Silicon Carbide Schottky Diode

1200V, 60A

Description

The 1200V eSiC is an advanced Power Master Semiconductor's silicon carbide diode family. This technology combines the benefits of excellent low forward voltage and robustness. Consequently, the eSiC family is suitable for application requiring high power efficiency.

Applications

- Power Factor Correction
- Industrial Power Supplies
- Solar Inverter, UPS

Features

V_{RRM}	I_F	$T_{J,max}$	Q_C
1200 V	60 A	175 °C	241 nC

- No reverse recovery current
- Low forward voltage
- 175°C Max junction temperature
- High surge current capability
- Switching behavior independent of temperature
- Pb-Free, Halogen Free and RoHS compliant

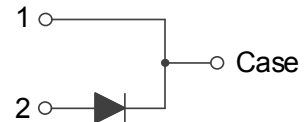
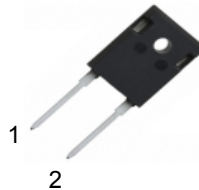

Absolute Maximum Ratings ($T_C = 25^\circ\text{C}$ unless otherwise noted)

Symbol	Parameter	Value	Unit	
V_{RRM}	Repetitive Peak Reverse Voltage	1200	V	
I_F	Forward Current	$T_C = T_{BD} \text{ } ^\circ\text{C}$	60	A
$I_{F,SM}$	Non-Repetitive Forward Surge Current	$T_C = 25^\circ\text{C}, t_p = 10 \text{ ms}$	225	A
		$T_C = 150^\circ\text{C}, t_p = 10 \text{ ms}$	191	A
$I_{F,Max}$	Non-Repetitive Peak Forward Current	$T_C = 25^\circ\text{C}, t_p = 10 \text{ } \mu\text{s}$	1570	A
		$T_C = 150^\circ\text{C}, t_p = 10 \text{ } \mu\text{s}$	1335	A
I^2dt value	$\int i^2 dt$	$T_C = 25^\circ\text{C}, t_p = 10 \text{ ms}$	253	A^2s
		$T_C = 150^\circ\text{C}, t_p = 10 \text{ ms}$	182	A^2s
P_{tot}	Power Dissipation	$T_C = 25^\circ\text{C}$	556	W
T_J, T_{STG}	Operating Junction and Storage Temperature	-55 to +175	$^\circ\text{C}$	

Thermal Characteristics

Symbol	Parameter	Value	Unit
$R_{\theta JC}$	Thermal Resistance, Junction to Case, Max.	0.27	$^\circ\text{C}/\text{W}$

Package Marking and Ordering Information

Part Number	Top Marking	Package	Packing Method	Quantity
HCA120S60D1Q	HCA120S60D1Q	TO-247-2L	Tube	30 units

Electrical Characteristics (Per Leg, $T_C = 25^\circ\text{C}$ unless otherwise noted)

Symbol	Parameter	Test Conditions	Min	Typ	Max	Unit
V_F	Forward Voltage	$I_F=60\text{ A}, T_C=25^\circ\text{C}$		1.63	1.95	V
		$I_F=60\text{ A}, T_C=175^\circ\text{C}$		2.0		
I_R	Reverse Current	$V_R=1200\text{ V}, T_C=25^\circ\text{C}$		-	100	μA
		$V_R=1200\text{ V}, T_C=175^\circ\text{C}$		-	300	
Q_C	Total Capacitive Charge	$V_R=800\text{ V}, T_C=25^\circ\text{C},$		241		nC
C	Total Capacitance	$V_R=1\text{ V}, f=100\text{ kHz}$		2638		pF
		$V_R=800\text{ V}, f=100\text{ kHz}$		165		
E_C	Capacitance Stored Energy	$V_R=800\text{ V}, T_C=25^\circ\text{C}$		69		μJ

Typical Performance Characteristics

Figure 1. Power Derating

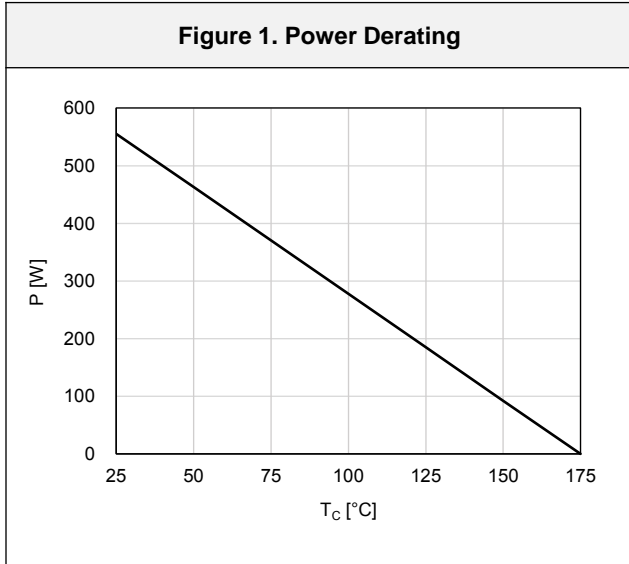

Figure 2. Current Derating

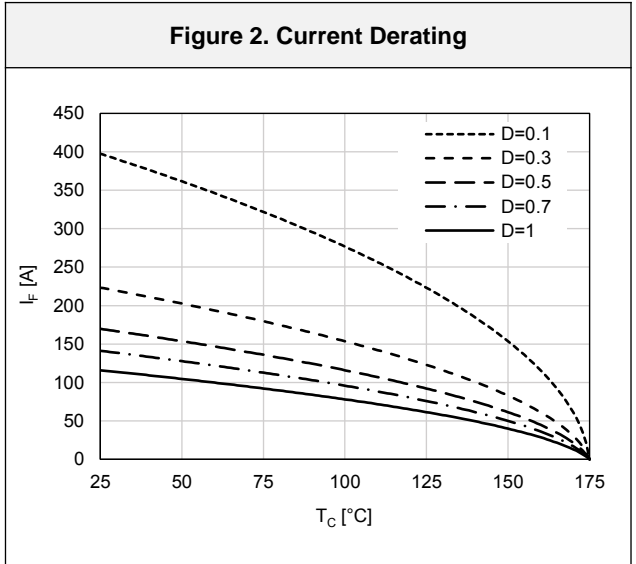

Figure 3. Forward Characteristics

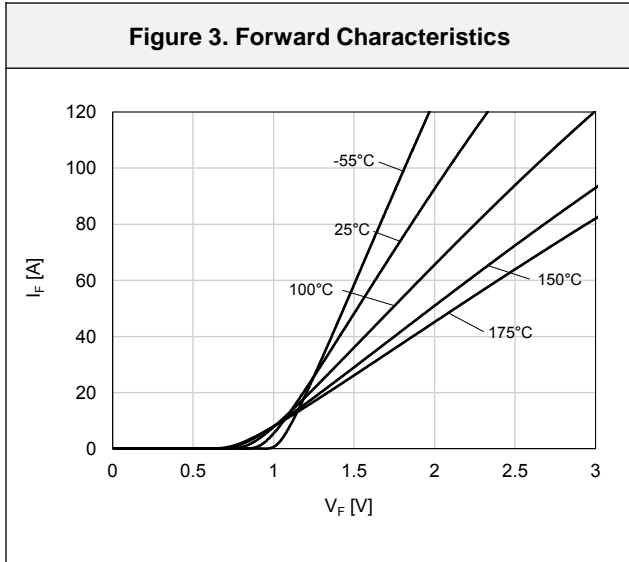

Figure 4. Reverse Characteristics

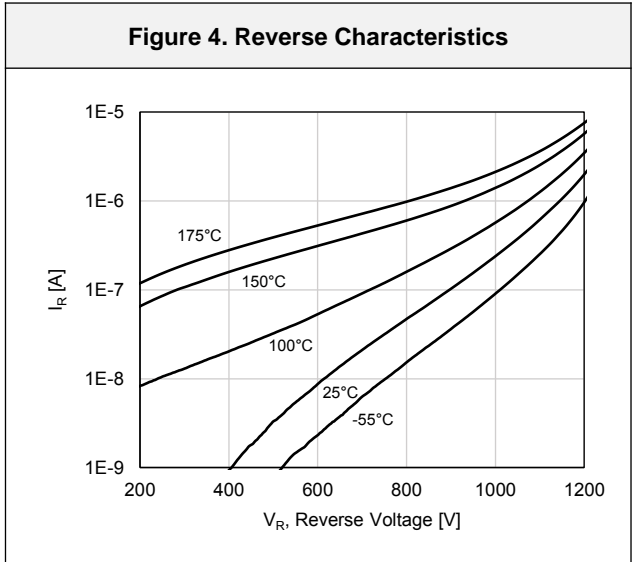

Figure 5. Capacitive Charge Characteristics

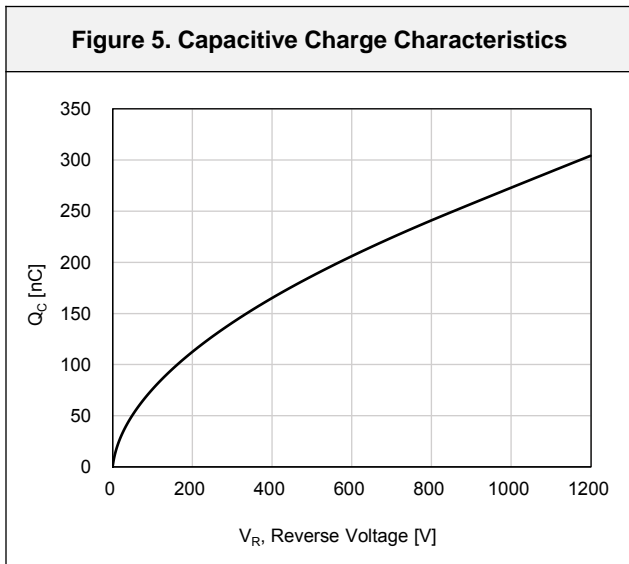
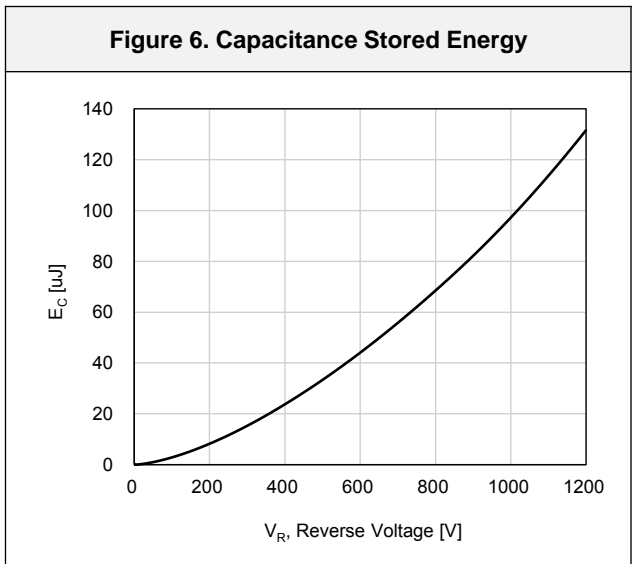

Figure 6. Capacitance Stored Energy



Typical Performance Characteristics

Figure 7. Capacitance Characteristics

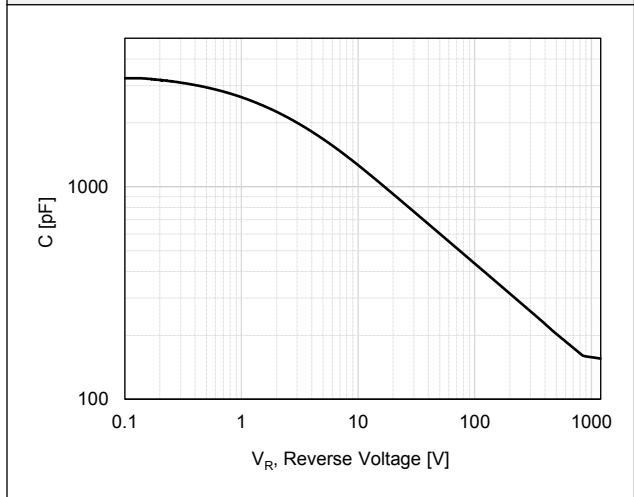
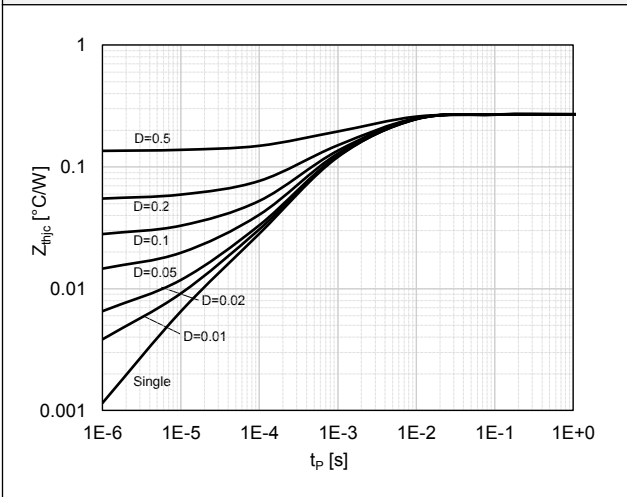
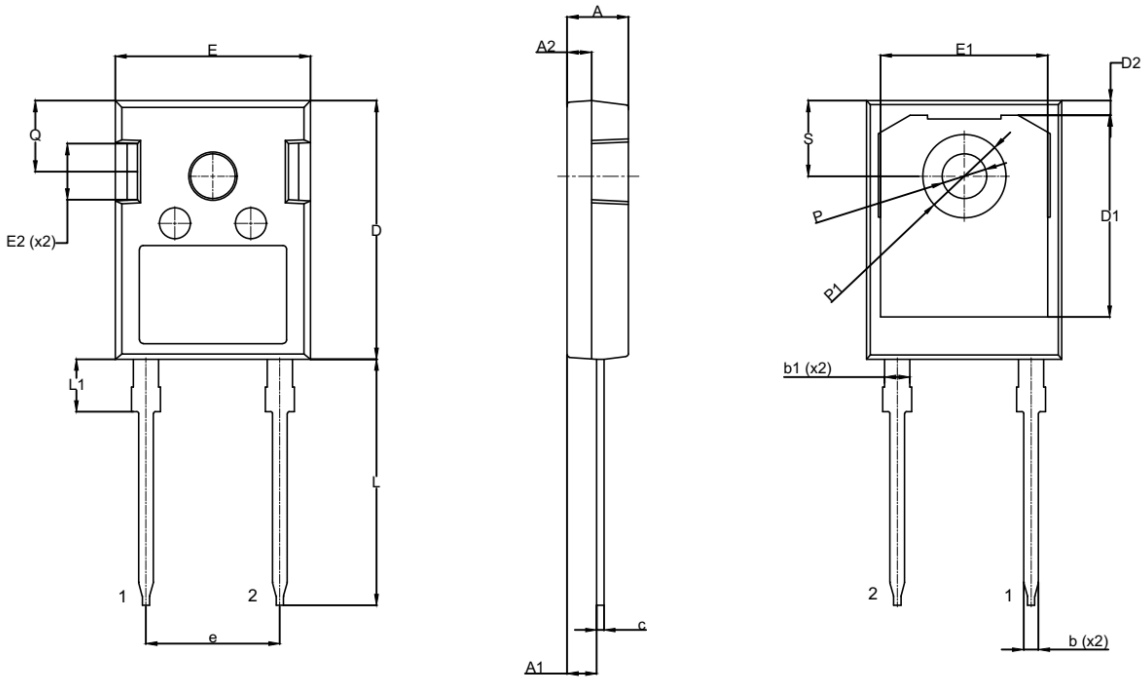

Figure 8. Transient Thermal Response Curve



Package Outlines
TO-247-2L



SYMBOL	Common		
	DIMENSIONS MILLIMETER		
	MIN.	NOM.	MAX.
A	4.80	5.00	5.20
A1	2.29	2.42	2.54
A2	1.90	2.00	2.10
b	1.10	1.20	1.30
b1	1.91	2.06	2.20
c	0.50	0.60	0.70
D	20.80	21.07	21.34
D1	16.26	16.46	16.66
D2	0.97	1.17	1.37
E	15.75	15.94	16.13
E1	13.46	13.66	13.86
E2	4.32	4.58	4.83
e	10.92 BSC.		
L	19.85	20.05	20.25
L1	4.05	4.27	4.48
P	3.56	3.61	3.66
P1	6.75	6.80	6.85
Q	5.38	5.79	6.20
S	6.15 BSC.		