

HCW120N16M2

N-Channel eSiC Silicon Carbide Power MOSFET

1200 V, 118 A, 16 mΩ

Features

- High switching speed with a low gate charge
- Fast intrinsic diode with low reverse recovery
- Robust Avalanche Capability
- 100% Avalanche Tested
- Pb-free, Halogen Free, and RoHS Compliant

$V_{DSS, T_C=25^\circ C}$	$I_D, T_C=25^\circ C$	$R_{DS(on), typ}$	$Q_{g, typ}$
1200 V	118 A	16 mΩ	152 nC

Benefits

- System efficiency improvement
- Higher frequency applicability
- Increased power density
- Reduced cooling effort

Applications

- Solar inverter
- EV charging station
- UPS
- Industrial power supply

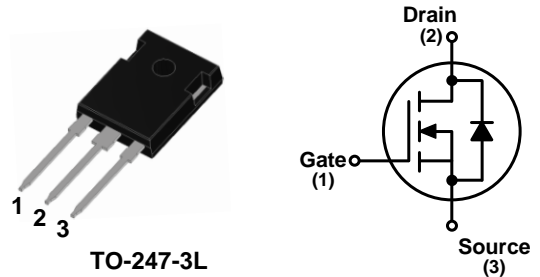

Absolute Maximum Ratings ($T_C = 25^\circ C$ unless otherwise noted)

Symbol	Parameter	Value	Unit
V_{DSS}	Drain to Source Voltage	1200	V
V_{GS}	Gate to Source Voltage (DC)	-10 / +22	V
V_{GSop}	Recommended Operation Value	-5...-3 / +18	V
I_D	Drain Current	Continuous ($T_C = 25^\circ C$)	118
		Continuous ($T_C = 100^\circ C$)	84
I_{DM}	Drain Current	Pulsed (Note1)	295
P_D	Power Dissipation	($T_C = 25^\circ C$)	500
		Derate Above $25^\circ C$	3.3
T_J, T_{STG}	Operating and Storage Temperature Range	-55 to 175	$^\circ C$
T_L	Maximum Lead Temperature for Soldering, 1/8" from Case for 10 Seconds	260	$^\circ C$

Thermal Characteristics

Symbol	Parameter	Value	Unit
$R_{\theta JC}$	Thermal Resistance, Junction to Case, Max.	0.30	$^\circ C/W$
$R_{\theta JA}$	Thermal Resistance, Junction to Ambient, Max.	40	

Package Marking and Ordering Information

Part Number	Top Marking	Package	Packing Method	Quantity
HCW120N16M2	HCW120N16M2	TO-247-3L	Tube	30 units

Electrical Characteristics ($T_C = 25^\circ\text{C}$ unless otherwise noted)

Symbol	Parameter	Test Conditions	Min	Typ	Max	Unit
--------	-----------	-----------------	-----	-----	-----	------

Off Characteristics

BV_{DSS}	Drain to Source Breakdown Voltage	$V_{GS} = 0\text{ V}, I_D = 1\text{ mA}$	1200			V
I_{DSS}	Zero Gate Voltage Drain Current	$V_{DS} = 1200\text{ V}, V_{GS} = 0\text{ V}$		1	100	μA
		$V_{DS} = 1200\text{ V}, V_{GS} = 0\text{ V}, T_J = 175^\circ\text{C}$		10		
I_{GSS}	Gate-Source Leakage Current	$V_{GS} = +22\text{ V}, V_{DS} = 0\text{ V}$			+100	nA
		$V_{GS} = -10\text{ V}, V_{DS} = 0\text{ V}$			-100	

On Characteristics

$V_{GS(th)}$	Gate Threshold Voltage	$V_{GS} = V_{DS}, I_D = 24\text{ mA}$ (tested after $V_{GS} = 22\text{ V}, 1\text{ ms pulse}$)	2.0	3.0	4.5	V
$R_{DS(on)}$	Static Drain to Source On Resistance	$V_{GS} = 18\text{ V}, I_D = 50\text{ A}$		16.0	22.4	$\text{m}\Omega$
		$V_{GS} = 18\text{ V}, I_D = 50\text{ A}, T_J = 175^\circ\text{C}$		25.6		
		$V_{GS} = 15\text{ V}, I_D = 50\text{ A}$		21.5		
g_{fs}	Transconductance	$V_{DS} = 20\text{ V}, I_D = 50\text{ A}$		32.7		S

Dynamic Characteristics

C_{iss}	Input Capacitance			4063		pF
C_{oss}	Output Capacitance	$V_{DS} = 800\text{ V}, V_{GS} = 0\text{ V}, f = 250\text{ kHz}$		227		
C_{rss}	Reverse Capacitance			3		
E_{oss}	Stored Energy in Output Capacitance			94		μJ
$C_{o(er)}$	Energy Related Output Capacitance	$V_{DS} = 0\text{ V to } 800\text{ V}, V_{GS} = 0\text{ V}$		295		pF
$C_{o(tr)}$	Time Related Output Capacitance			476		
$Q_{g(tot)}$	Total Gate Charge	$V_{DS} = 800\text{ V}, I_D = 50\text{ A},$ $V_{GS} = -3\text{ V} / 18\text{ V},$ Inductive load		152		nC
Q_{gs}	Gate to Source Charge			49		
Q_{gd}	Gate to Drain "Miller" Charge			29		
R_G	Internal Gate Resistance	$f = 1\text{ MHz}, V_{AC} = 30\text{ mV}$		2.7		Ω

Switching Characteristics

$t_{d(on)}$	Turn-On Delay Time	$V_{DS} = 800\text{ V}, I_D = 50\text{ A},$ $V_{GS} = -3\text{ V} / 18\text{ V}, R_G = 4.7\ \Omega,$ FWD : PCH120S20D1, Inductive load		34		ns
t_r	Turn-On Rise Time			54		
$t_{d(off)}$	Turn-Off Delay Time			68		
t_f	Turn-Off Fall Time			13		
E_{on}	Turn-on Switching Energy			1325		μJ
E_{off}	Turn-off Switching Energy			455		
E_{tot}	Total Switching Energy			1780		

Electrical Characteristics ($T_C = 25^\circ\text{C}$ unless otherwise noted)

Symbol	Parameter	Test Conditions	Min	Typ	Max	Unit
Source-Drain Diode Characteristics						
I_S	Continuous Diode Forward Current	$V_{GS} = -3\text{ V}$			105	A
I_{SM}	Pulsed Diode Forward Current	$V_{GS} = -3\text{ V}$ (Note1)			295	
V_{SD}	Diode Forward Voltage	$V_{GS} = -3\text{ V}, I_{SD} = 50\text{ A}$		4.0		V
t_{rr}	Reverse Recovery Time	$V_{DD} = 800\text{ V}, I_{SD} = 50\text{ A},$ $di_F/dt = 1200\text{ A}/\mu\text{s},$ Includes Q_{oss}		43		ns
Q_{rr}	Reverse Recovery Charge			420		nC
I_{rrm}	Peak Reverse Recovery Current			17		A

※Note 1 : Limited by maximum junction temperature.

Typical Performance Characteristics

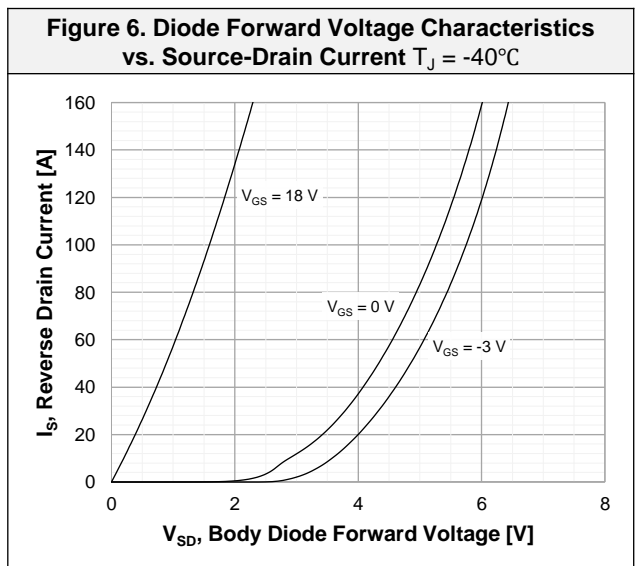
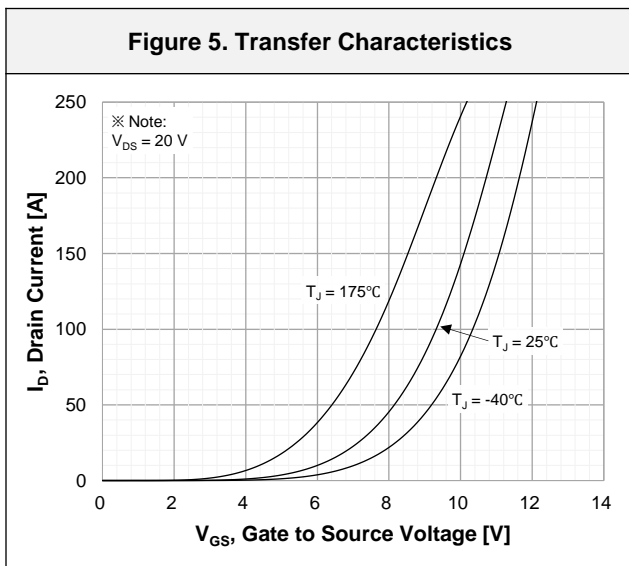
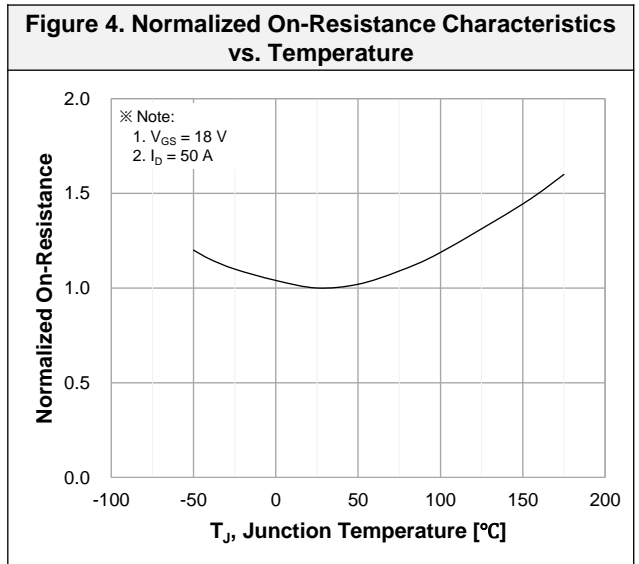
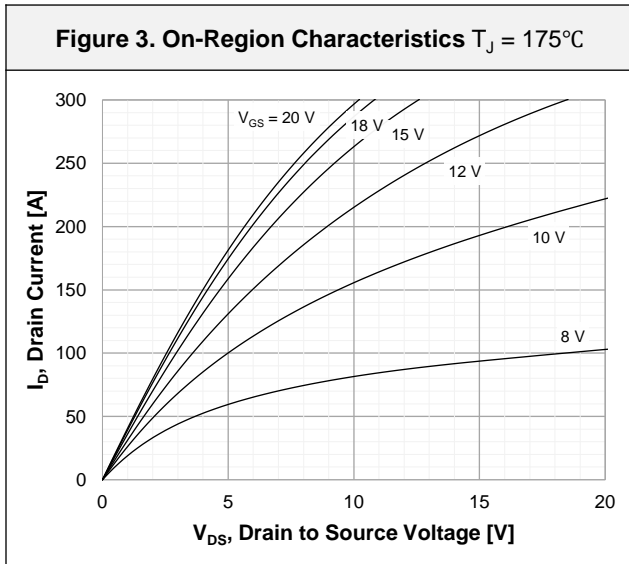
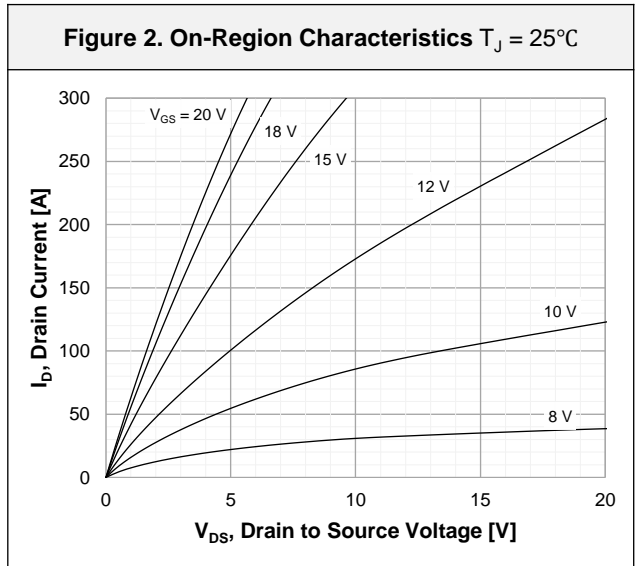
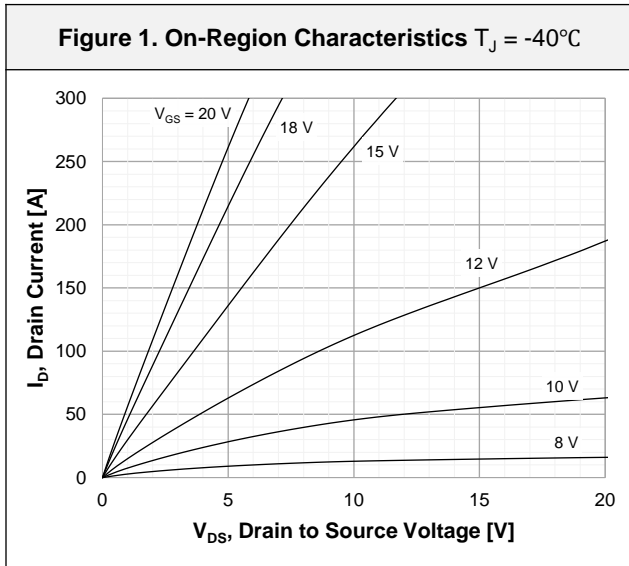

Typical Performance Characteristics

Figure 7. Diode Forward Voltage Characteristics vs. Source-Drain Current $T_J = 25^\circ\text{C}$

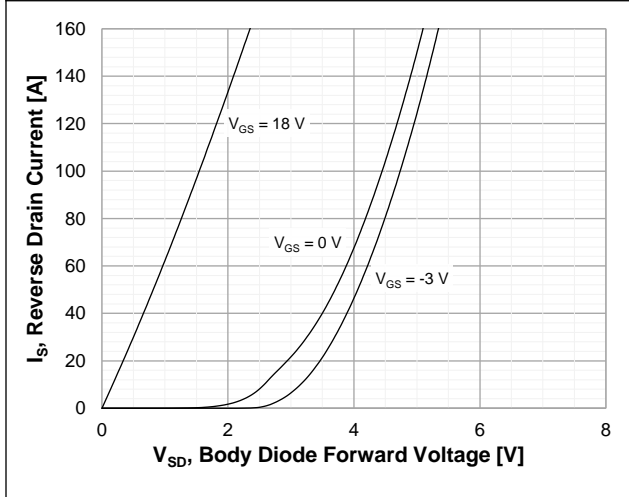

Figure 8. Diode Forward Voltage Characteristics vs. Source-Drain Current $T_J = 175^\circ\text{C}$

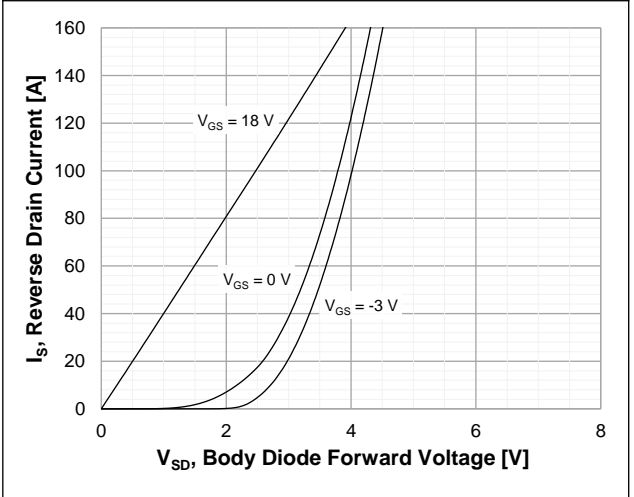

Figure 9. Threshold Voltage vs. Temperature

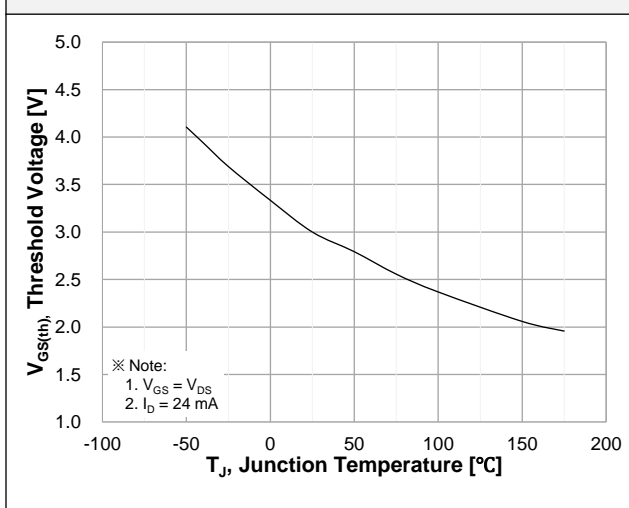

Figure 10. Gate Charge Characteristics

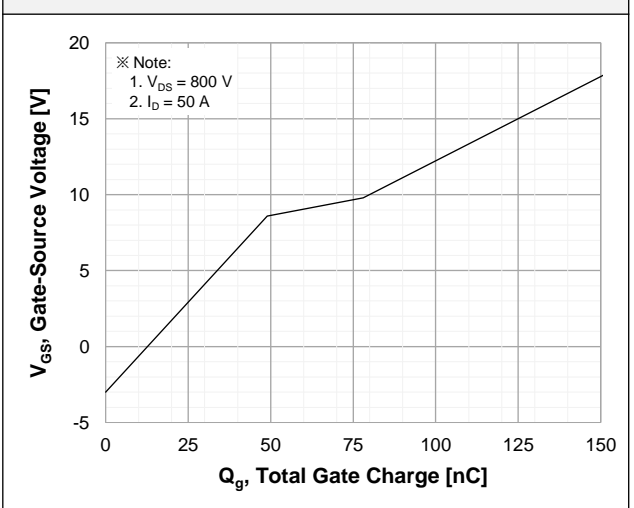

Figure 11. Stored Energy in Output Capacitance

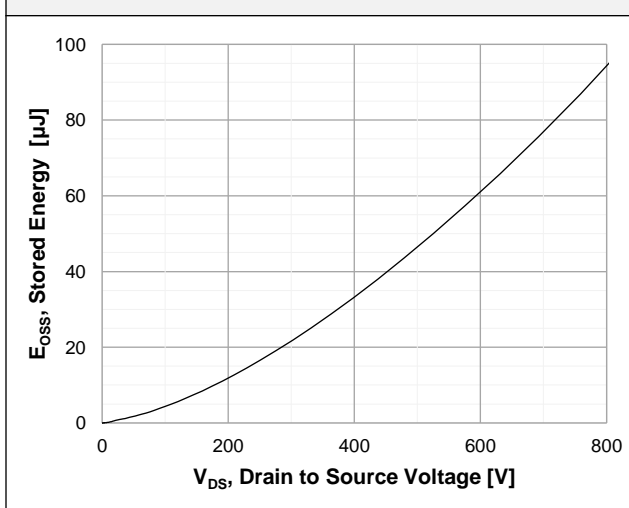
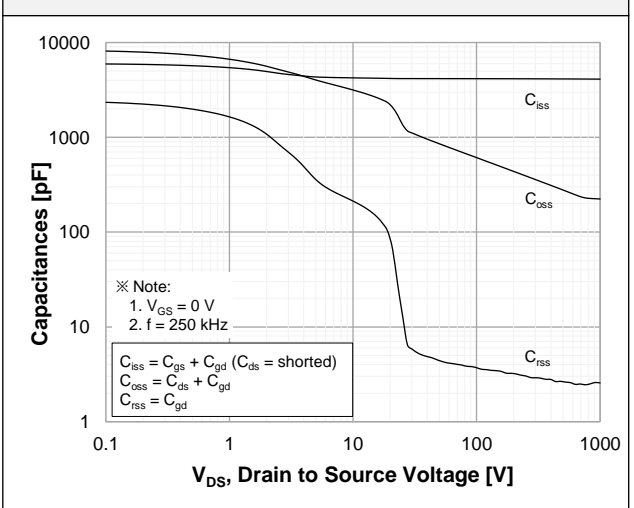

Figure 12. Capacitance Characteristics



Typical Performance Characteristics

Figure 13. Continuous Drain Current Derating vs. Case Temperature

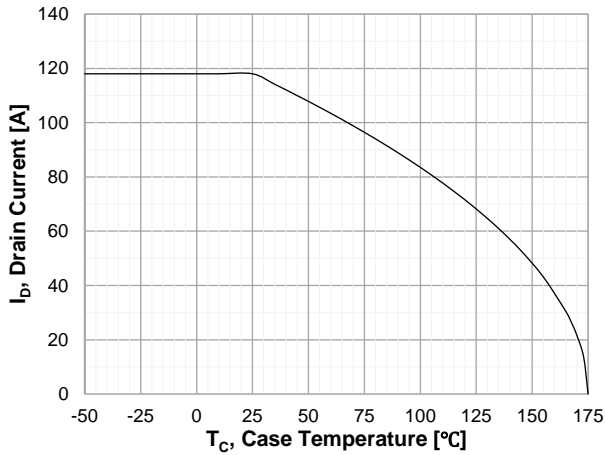

Figure 14. Maximum Power Dissipation Derating vs. Case Temperature

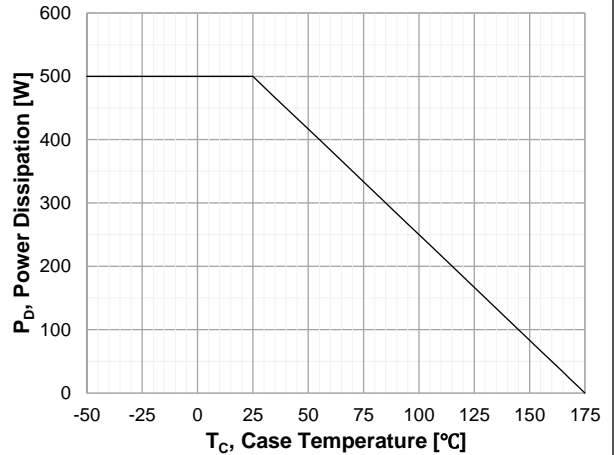

Figure 15. Typ. Switching Losses vs. Drain Current

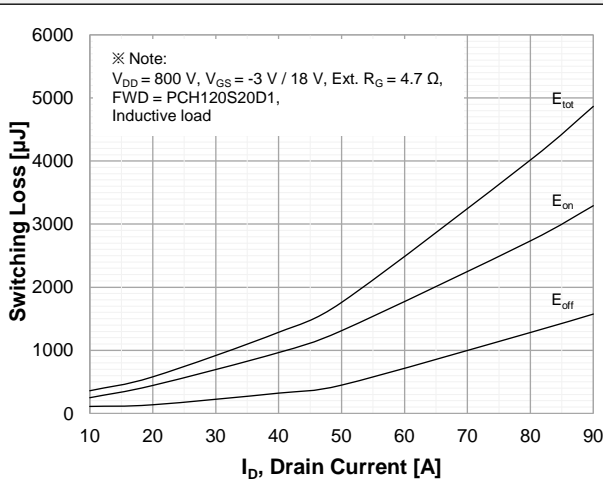

Figure 16. Typ. Switching Losses vs. Gate Resistance

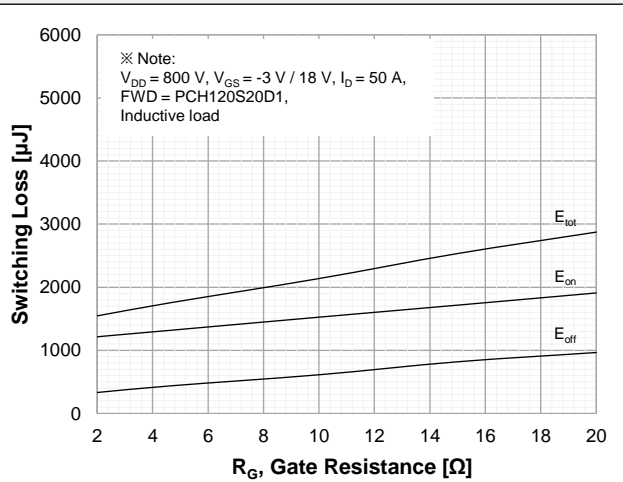

Figure 17. Typ. Switching Losses vs. Drain Current

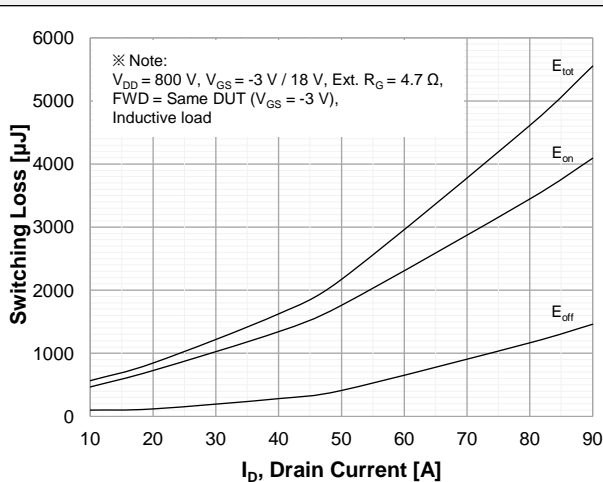
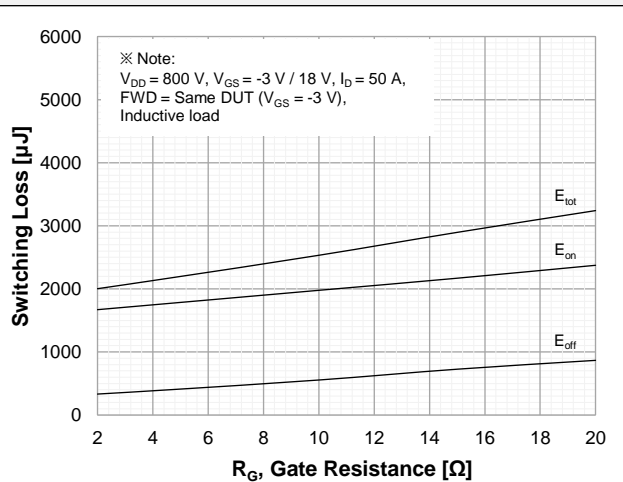

Figure 18. Typ. Switching Losses vs. Gate Resistance



Typical Performance Characteristics

Figure 19. Maximum Safe Operating Area

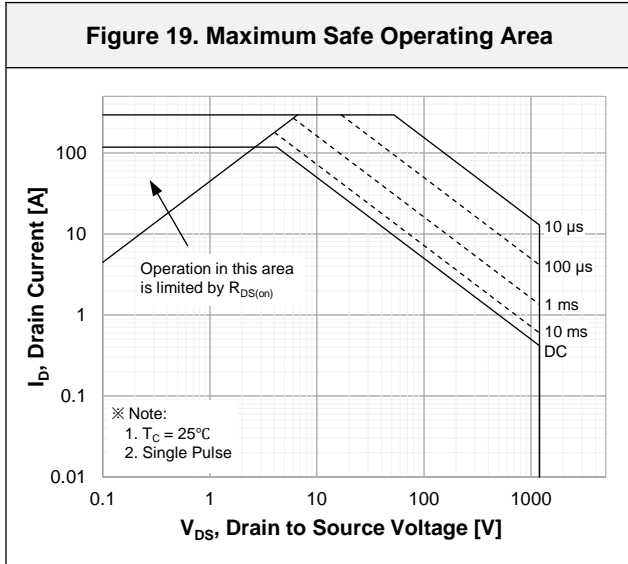

Figure 20. Transient Thermal Response Curve

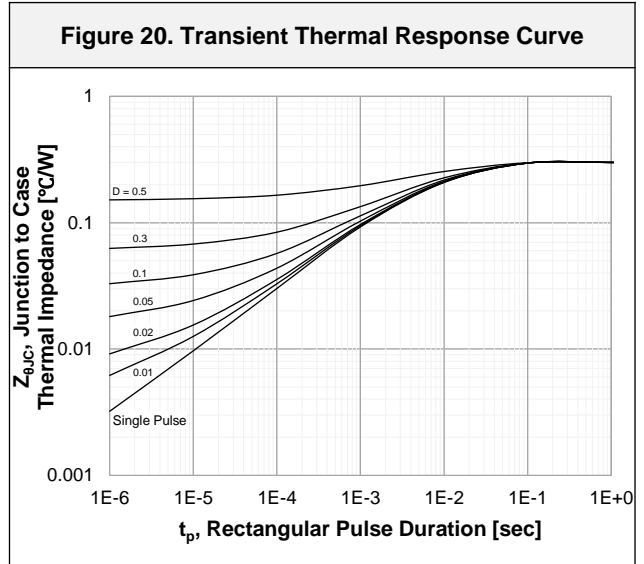

Figure 21. Inductive Load Switching Test Circuit and Waveforms

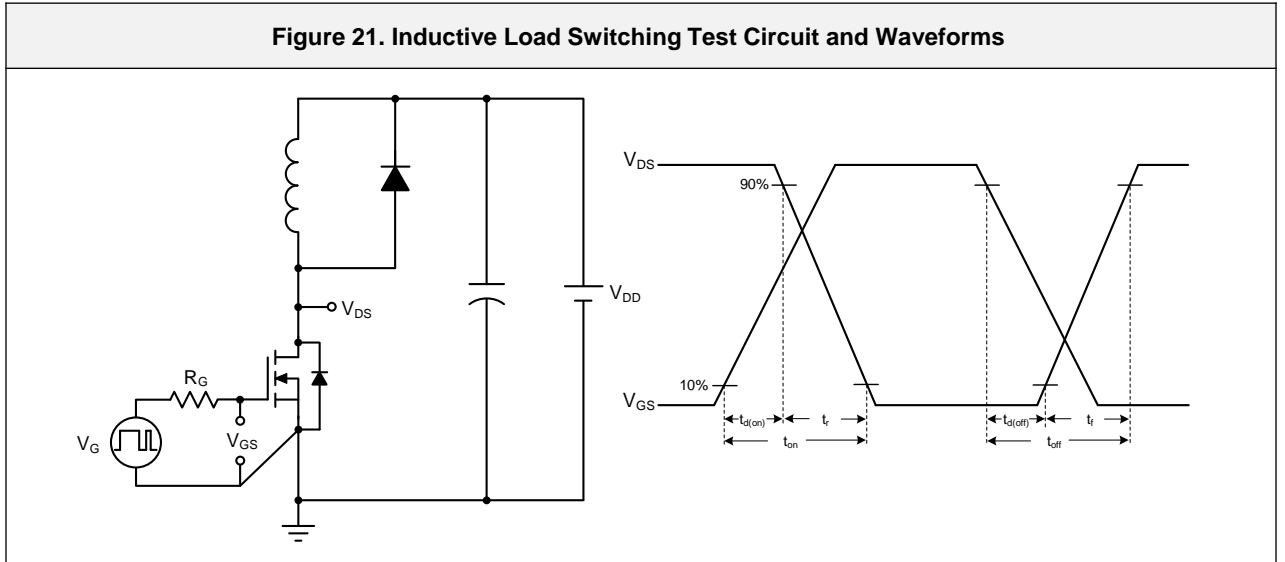
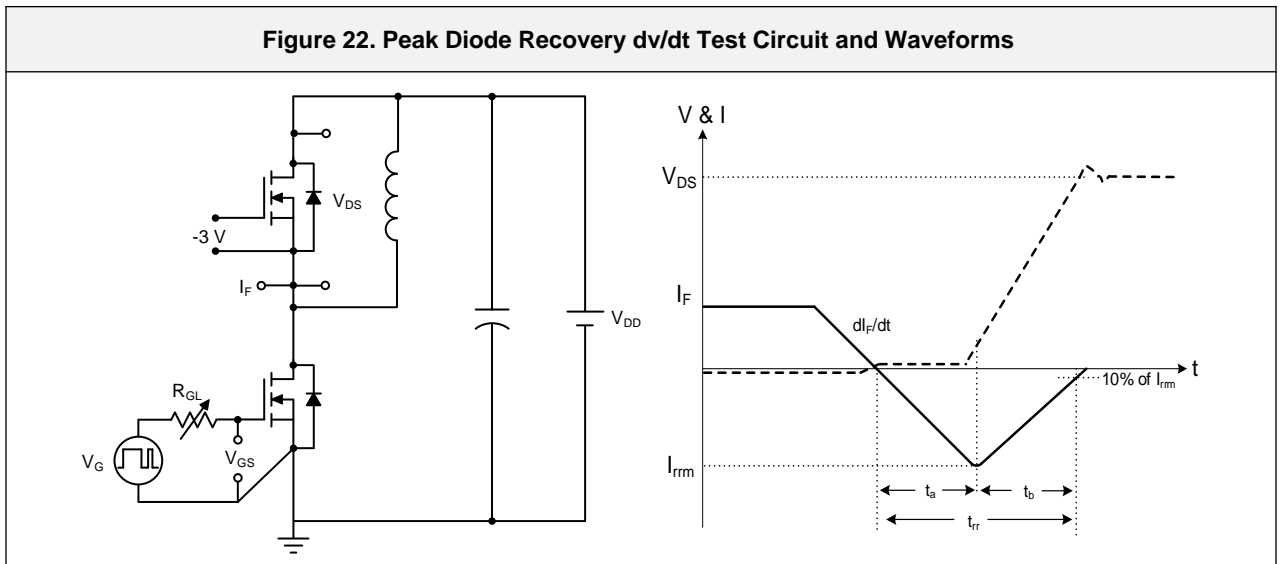
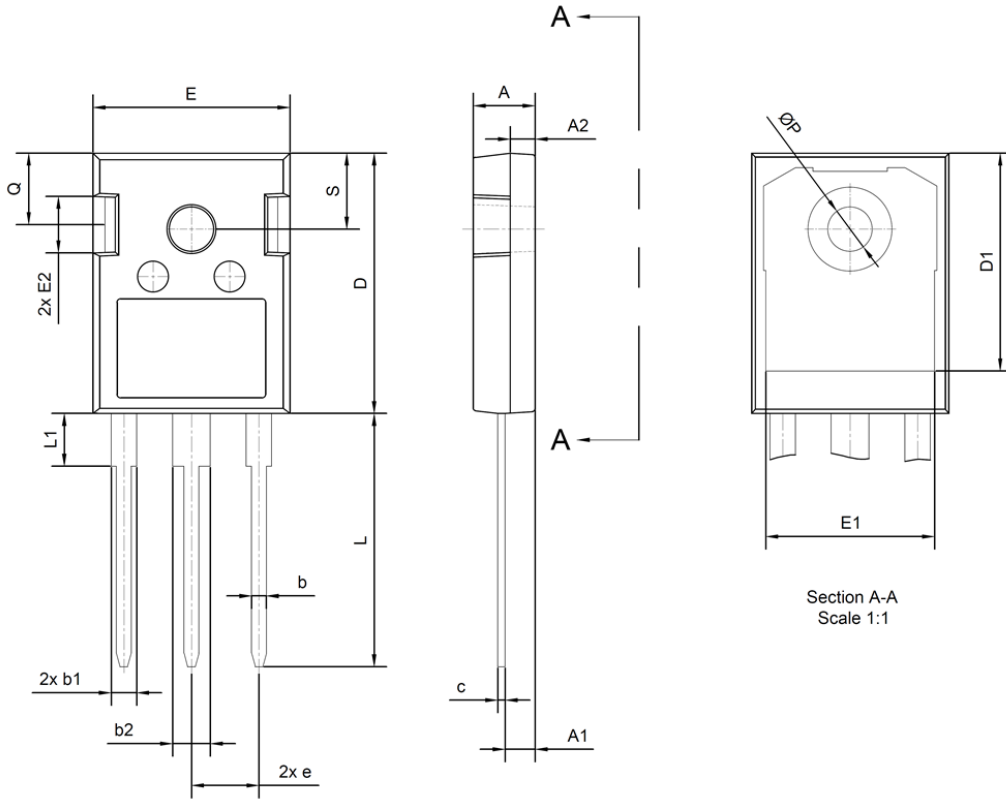

Figure 22. Peak Diode Recovery dv/dt Test Circuit and Waveforms



Package Outlines
TO-247-3L



Section A-A
 Scale 1:1

SYMBOL	Common		
	DIMENSIONS MILLIMETER		
	MIN.	NOM.	MAX.
A	4.80	5.00	5.20
A1	2.29	2.42	2.54
A2	1.90	2.00	2.10
b	1.10	1.20	1.30
b1	1.91	2.06	2.20
b2	2.92	3.06	3.20
c	0.50	0.60	0.70
D	20.80	21.07	21.34
D1	17.23	17.63	18.03
E	15.75	15.94	16.13
E1	13.46	13.66	13.86
E2	4.32	4.58	4.83
e	5.46 BSC		
L	19.85	20.05	20.25
L1	4.05	4.27	4.48
ØP	3.56	3.61	3.66
Q	5.38	5.79	6.20
S	6.15 BSC		

* Dimensions in millimeters