

HCW65D20D1

eSiC Silicon Carbide Schottky Diode

650V, 20A

Description

The 650V eSiC is an advanced Power Master Semiconductor's silicon carbide diode family.

This technology combines the benefits of excellent low forward voltage and robustness.

Consequently, the eSiC family is suitable for application requiring high power efficiency.

Applications

- Power Factor Correction
- Industrial Power Supplies
- Solar Inverter, UPS

Features

V_{RRM}	I_F	$T_{J,max}$	Q_C
650 V	10 / 20 A	175 °C	39nC

- No reverse recovery current
- Low forward voltage
- 175°C Max junction temperature
- High surge current capability
- Switching behavior independent of temperature
- Pb-Free, Halogen Free and RoHS compliant

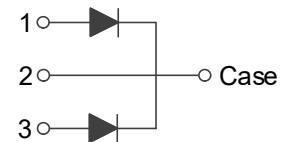
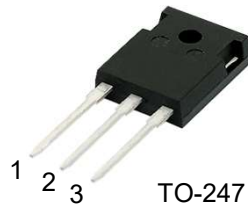

Absolute Maximum Ratings (Per Leg / Device & Per Leg, $T_C = 25^\circ\text{C}$ unless otherwise noted)

Symbol	Parameter	Value	Unit
V_{RRM}	Repetitive Peak Reverse Voltage	650	V
I_F	Forward Current	$T_C=144^\circ\text{C}$ 10 / 20	A
$I_{F,SM}$	Non-Repetitive Forward Surge Current	$T_C=25^\circ\text{C}$, $t_p=10$ ms	55
		$T_C=150^\circ\text{C}$, $t_p=10$ ms	46
$I_{F,Max}$	Non-Repetitive Peak Forward Current	$T_C=25^\circ\text{C}$, $t_p=10$ us	665
		$T_C=150^\circ\text{C}$, $t_p=10$ us	565
I^2dt value	$\int i^2 dt$	$T_C=25^\circ\text{C}$, $t_p=10$ ms	15.1
		$T_C=150^\circ\text{C}$, $t_p=10$ ms	10.6
P_{tot}	Power Dissipation	$T_C=25^\circ\text{C}$ 83	W
T_J, T_{STG}	Operating Junction and Storage Temperature	-55 to +175	$^\circ\text{C}$

Thermal Characteristics

Symbol	Parameter	Value	Unit
$R_{\theta JC}$	Thermal Resistance, Junction to Case, Max.(Per Leg / Per Device)	1.8 / 0.9	$^\circ\text{C/W}$

Package Marking and Ordering Information

Part Number	Top Marking	Package	Packing Method	Quantity
HCW65D20D1	HCW65D20D1	TO-247	Tube	30 units

Electrical Characteristics (Per Leg, $T_C = 25^\circ\text{C}$ unless otherwise noted)

Symbol	Parameter	Test Conditions	Min	Typ	Max	Unit
V_F	Forward Voltage	$I_F=10\text{ A}, T_C=25^\circ\text{C}$		1.30	1.6	V
		$I_F=10\text{ A}, T_C=175^\circ\text{C}$		1.45	-	
I_R	Reverse Current	$V_R=650\text{ V}, T_C=25^\circ\text{C}$		-	100	μA
		$V_R=650\text{ V}, T_C=175^\circ\text{C}$		-	300	
Q_C	Total Capacitive Charge	$V_R=400\text{ V}, T_C=25^\circ\text{C}$		39		nC
C	Total Capacitance	$V_R=1\text{ V}, f=100\text{ kHz}$		624		pF
		$V_R=400\text{ V}, f=100\text{ kHz}$		61		
E_C	Capacitance Stored Energy	$V_R=400\text{ V}, T_C=25^\circ\text{C}$		5.8		μJ

Typical Performance Characteristics (Per Leg)

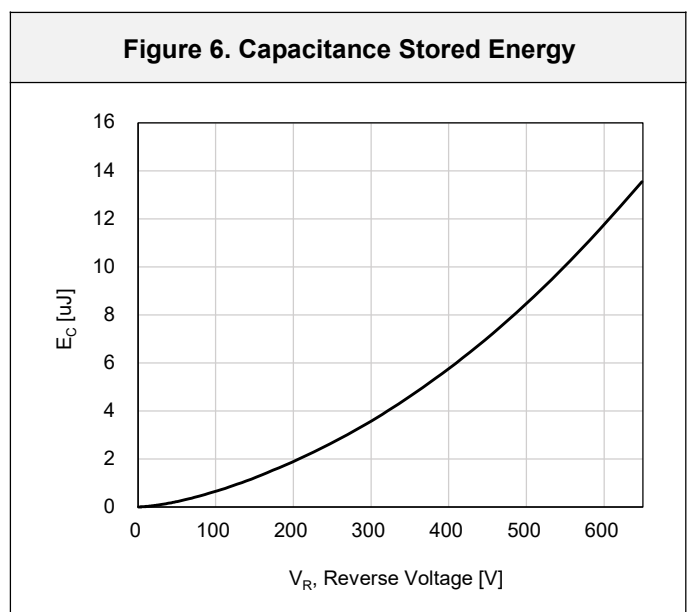
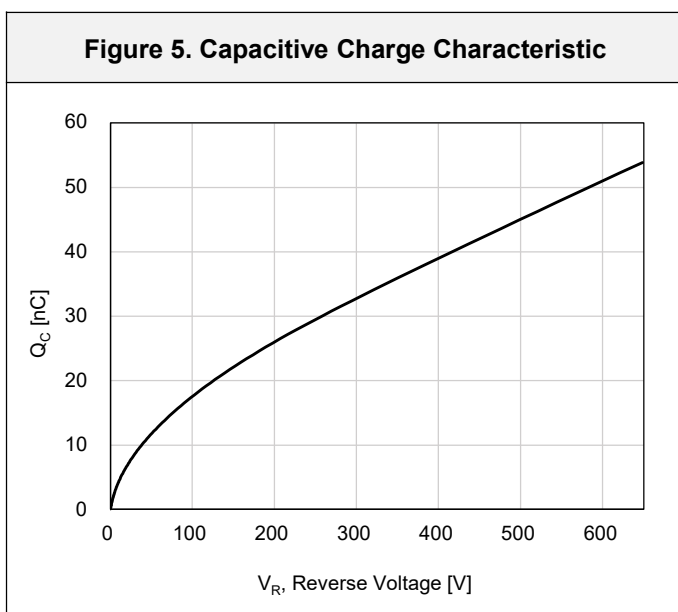
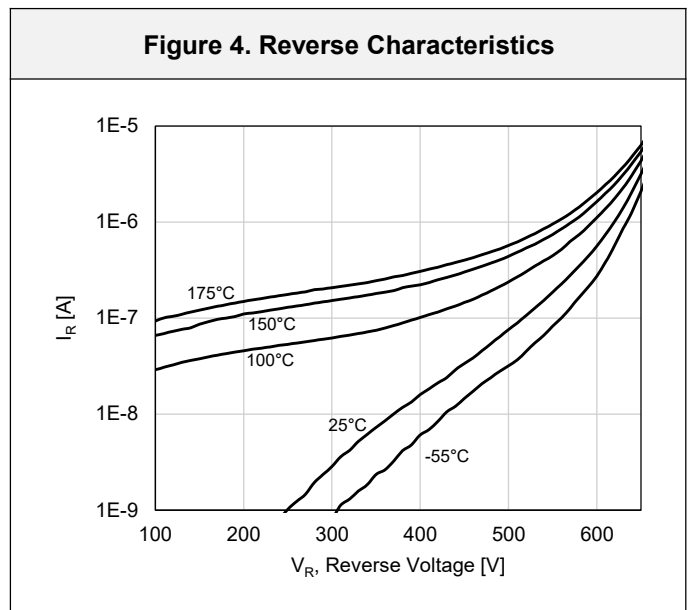
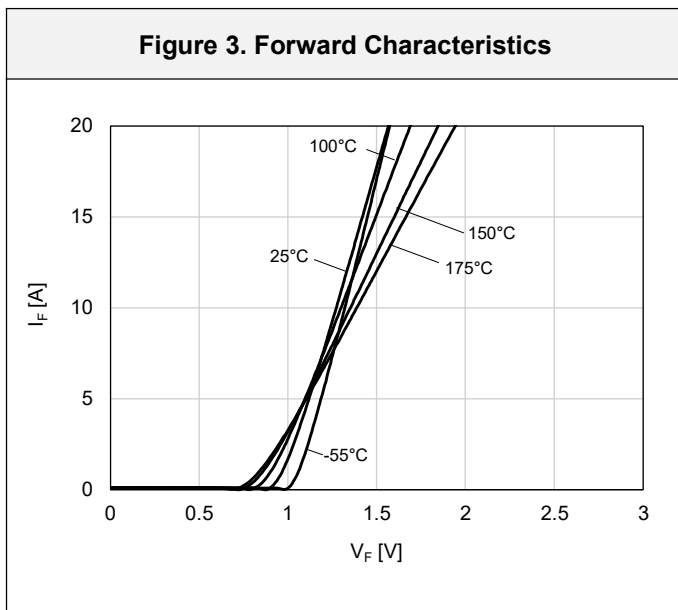
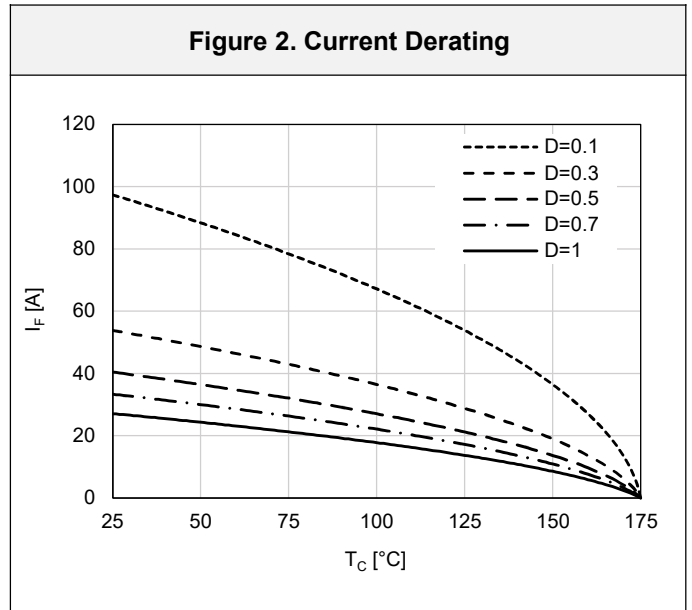
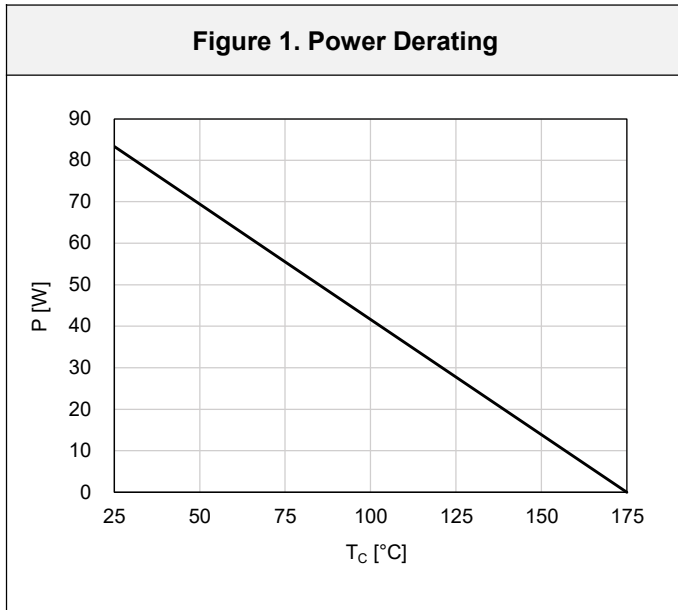

Typical Performance Characteristics (Per Leg)

Figure 7. Capacitance Characteristic

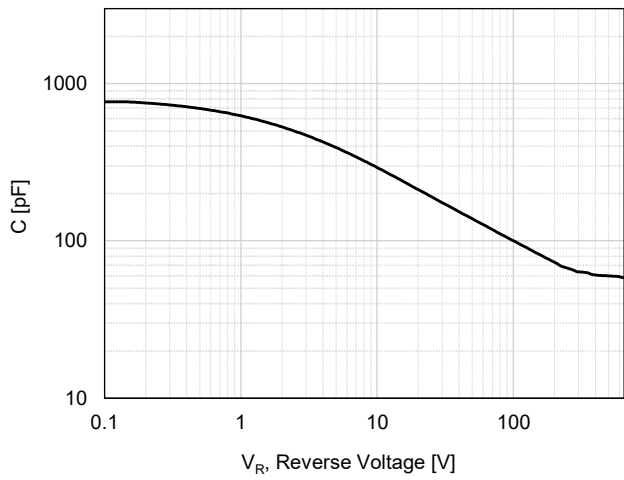
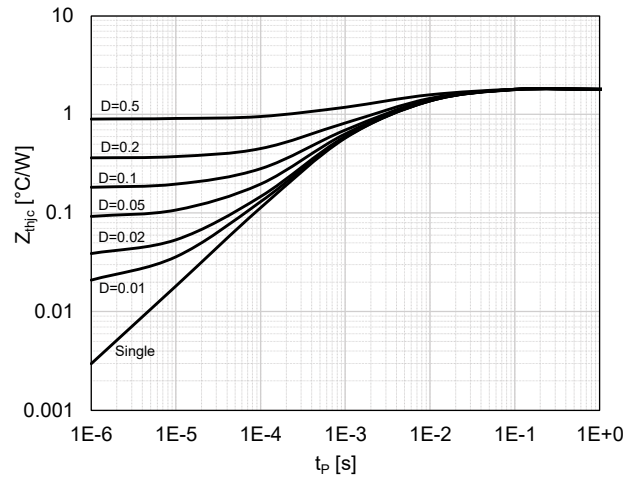
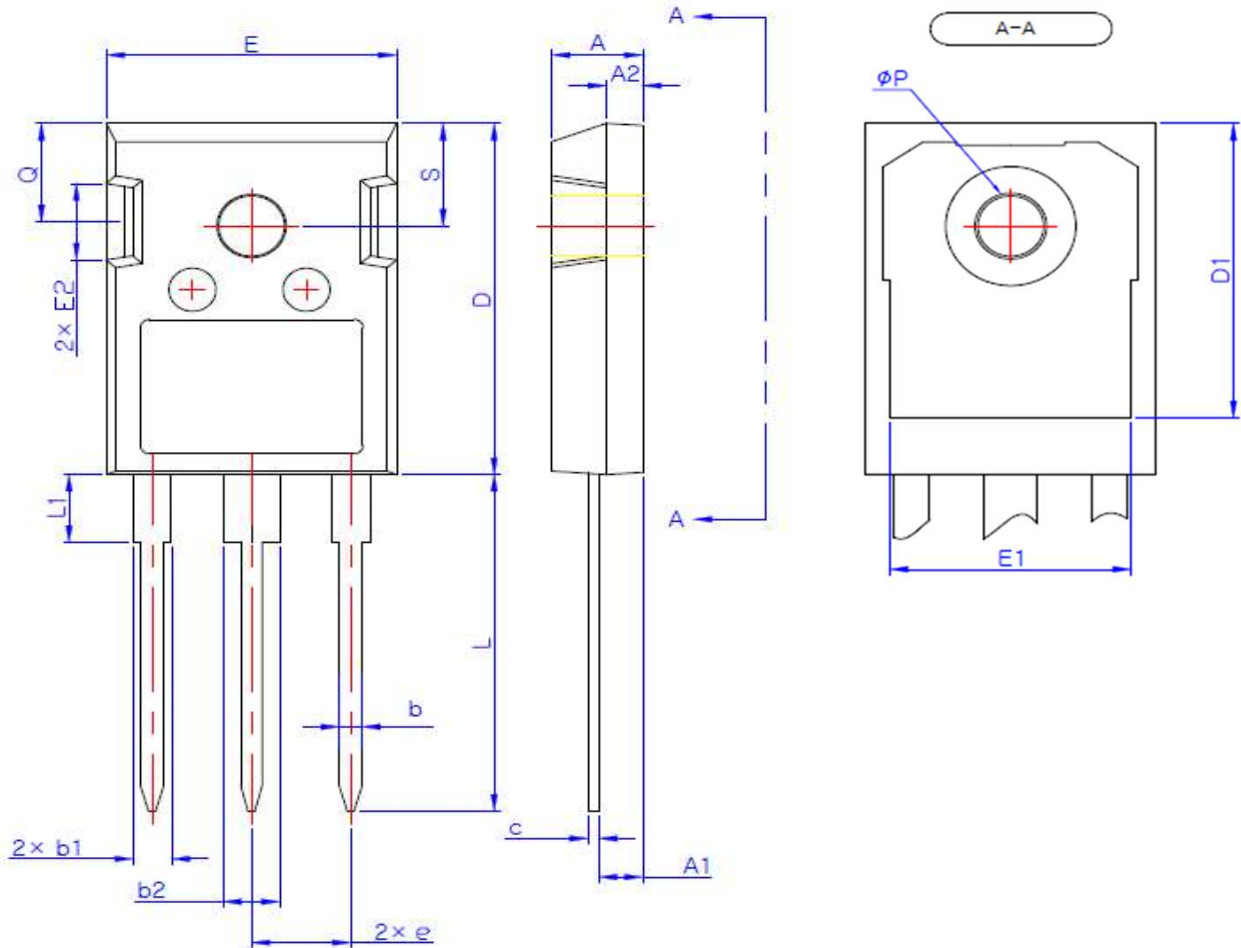

Figure 8. Transient Thermal Response Curve



Package Outlines

TO-247



SYMBOL	MIN	NOM	MAX
A	4.80	5.00	5.20
A1	2.29	2.42	2.54
A2	1.90	2.00	2.10
b	1.10	1.20	1.30
b1	1.91	2.06	2.20
b2	2.92	3.06	3.20
c	0.50	0.60	0.70
D	20.80	21.07	21.34
D1	17.43	17.63	17.83
E	15.75	15.94	16.13
E1	13.06	13.26	13.46
E2	4.32	4.58	4.83
e	5.45 BSC		
L	19.85	20.05	20.25
L1	4.05	4.27	4.49
phi P	3.55	3.60	3.65
Q	5.59	5.89	6.19
S	6.15 BSC		

* Dimensions in millimeters